

文件名/NAME	热熔充填机英文说明书 Fi-G CE 无LOGO	代码/CODE	14.02.11.001
尺寸/SIZE	130×190mm, 出血6mm	版本/REV.	V1.7
材质/MATERIAL	120g 铜版纸		
装订&注释/ bind (books etc) &NOTES	骑马订; 保修卡正反面印刷需对应。	印刷颜色/COLORS	4X4  CMYK
修订日期/DATE	2024年07月24日		

请勿打印此页, 仅供参考。/DO NOT PRINT THIS PAGE, REFERENCE ONLY.

# Gutta Percha Obturation Device Instruction Manual

**CE** 0197

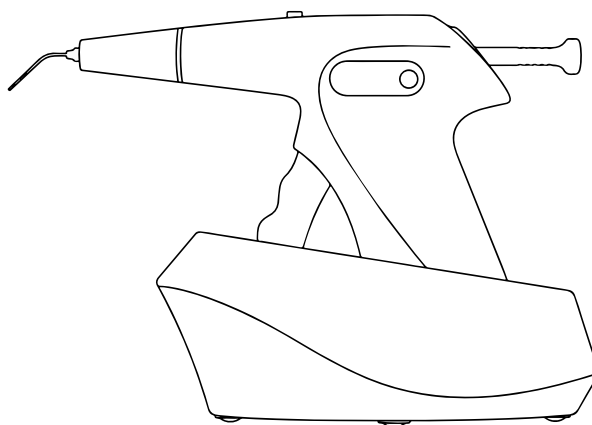

**Fi-G**

ZMN-SM-038 V1.7-20240724



**Guilin Woodpecker Medical Instrument Co., Ltd.**

# Contents

Introduction-----	1
1 Product introduction-----	1
2 European authorized representative-----	8
3 Standard icons-----	8
4 Contraindications-----	9
5 Installation and disassembly method of accessories-----	9
6 Operation method-----	11
7 Charging instruction-----	13
8 Safety precautions-----	13
9 Cleaning, Disinfection, Sterilization and Maintenance-	14
10 Troubleshooting-----	20
11 After-sales service-----	22
12 Environment protection-----	22
13 EMC-Declaration of conformity-----	22
14 Statement-----	26

## **Introduction**

Thank you for purchase Fi-G Hot Melting and Filling Instrument developed by Guilin Woodpecker Medical Instrument Co., Ltd, a Hi-tech enterprise developing, manufacturing, and selling dental instruments. Woodpecker has excellent Quality Control System. To guarantee correct and safe operation, please read this Instruction Manual carefully before use. Depending on the level of risk involved, safety requirements are classed under the following indications:

-  Danger: (always referred to personal injury)
-  warning: (referred to possible damage to property)

## **1 Product introduction**

### 1.1 Intended use

Heat up and soften gutta-percha, and fill the gutta-percha into the root canal after preparation. And the applied part is Gutta Percha Injecting Needle.

### 1.2 Diagram of components and control buttons

The Fi-G is equipped with a display screen and a control button on both the left and right sides. And the design of left and right sides are perfectly symmetrical, which enables either left-hand or right-hand operation;

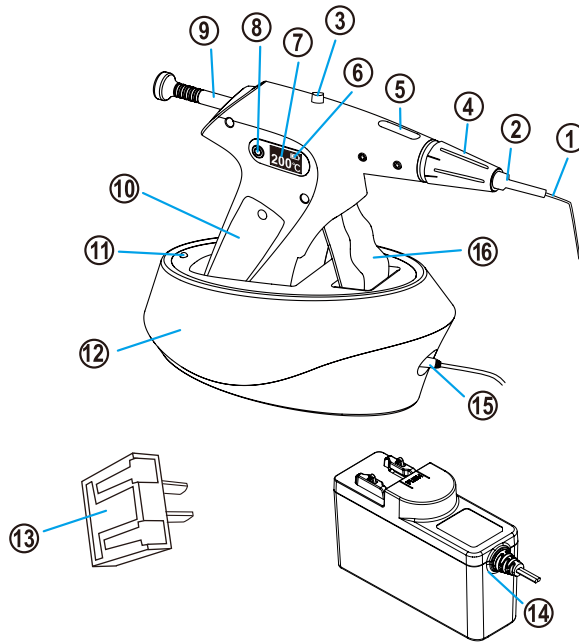

- |  |                          |
|--|--------------------------|
| 1. Gutta Percha Injecting Needle           |                          |
| 2. Gutta Percha Injecting Needle Protector |                          |
| 3. Limit switch                            | 4. Thermal Protector Cap |
| 5. Gutta-percha loading slot               | 6. Battery level         |
| 7. Temperature Level                       | 8. "ON/OFF" button       |
| 9. Pushing ram                             | 10. Battery cover        |
| 11. Charging indicator                     | 12. Charging base        |
| 13. Power adapter plug                     | 14. Power adapter unit   |
| 15. Connecting hole for power supply       |                          |
| 16. Trigger                                |                          |

1) "ON/OFF" button:

a) In the OFF state, long press the left or right "ON/OFF" button can turn on the power. After the power is turned on, the left and right displays will be lit at the same time.

b) In the ON state, long press the left or right "ON/OFF" button can turn off the power.

**Note:** If there is no operation for 10 minutes, the Hot Melting and Filling Instrument will automatically shut down.

2) Temperature control button: ( Note: The temperature control button and the “ON/OFF” button are the same button. After powers on, the button acts as temperature control button. )

Lightly press the button to change the preset temperature for heating the gutta-percha. The temperature will change in the sequence of 150°C→180°C→200°C→230°C as shown in Figure 1, and back to 150°when you press the button in 230°C.



Figure 1 Preset temperature

Gutta Percha Injecting Needle	Temperature
25G	180°C-230°C
23G	180°C-200°C
20G	180°C-200°C

Table 1 Recommended temperature setting

3) Limit switch:

Keep pushing the limit switch to pull the Pushing ram backward.

 **Warning:**

Do not pull the Pushing ram backward without pressing the limit switch all the time.

4) Battery level:

The actual power of the battery is displayed in real time on the screen. When the battery is fully charged, the power of the OLED display is displayed as five grids. When the battery level is one grid, it indicates that the battery is low and needs to be charged in time. When the battery level is displayed as a space, it indicates that the battery is very low and needs to be charged immediately.

**Note:** During normal use, try not to let the battery level reduced to space status (completely no power) before charge, which will shorten the service life of battery.

 **Warning:**

If the device has not been used for more than one month, the battery needs to be recharged. If the device is not in use for a long time, please be sure to charge it at least once a month to protect the battery. The service life of battery of Hot Melting and Filling Instrument will be shortened

when it is in a low battery state for a long time or when it leaves the charging base for a long time.

#### 5) Temperature Level:

When the temperature is preset, the display screen shows the preset temperature value. About 1s after the temperature preset, the OLED screen will display the real-time temperature inside heating chamber.

When the Hot Melting and Filling Instrument is in the heating state, the temperature indicator will simultaneously display the current temperature.

#### 6) Charging base:

Firstly, connect the power adapter plug to the power adapter as shown in Figure 2. Then connect the power adapter to the charging base as shown in Figure 3 and connect the power adapter to a standard socket. Place the Hot Melting and Filling Instrument correctly on the charging base as shown in Figure 4, so that the charging connector under the Hot Melting and Filling Instrument can be reliably connected to the output connector of the charging base. When the Hot Melting and Filling Instrument is properly connected to the charging base, the LED charging indicator on the base will be on constantly. If the LED is flashing or not lit, please check all the cables carefully.

There are charging status indicators on the charging base. When the Hot Melting and Filling Instrument is not placed on the charging base, the indicator will flashes in yellow and green alternately. When the Hot Melting and Filling Instrument is placed on the charging base, if the charging is being charged, the yellow indicator will be on constantly. When the battery is full, the yellow indicator will be off and the green indicator will be on constantly.

**Notes:** After receiving the device, please charge it immediately. Before use, please be sure that battery is fully charged. When the device is fully charged, the battery level of the Hot Melting and Filling Instrument led display screen is the highest. After the battery runs out, the time of battery charging takes at least 2 hours and 30 minutes.

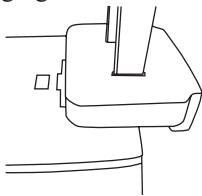

Figure 2 Installation of power adapter

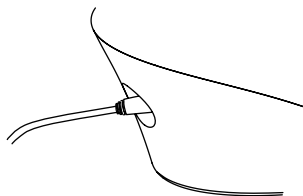

Figure 3 Connection to power supply

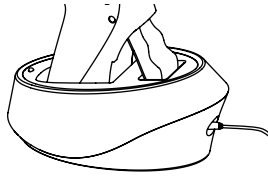
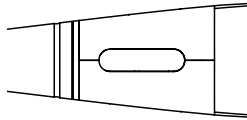

Figure 4 Charging

7) Gutta-percha loading slot:

Note: Only one gutta-percha can be loaded into it for a time.



8) Thermal Protector Cap:

The design of Thermal Protector Cap is to protect the oral soft tissue and lip from scalding.

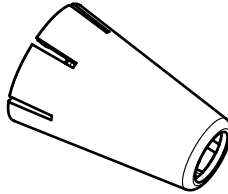

Note: Before use, please clean, disinfect and sterilize the Thermal Protector Cap.

9) Gutta Percha Injecting Needle



Note:

1. Store unused Gutta Percha Injecting Needles in a sealed environment, as the Gutta Percha Injecting Needle are made of silver and may discolor due to oxidation caused by long-term exposure to air.

2. Please use the wrench provided by the company to connect, disassemble and pre-bend the Gutta Percha Injecting Needle.



10) Wrench:

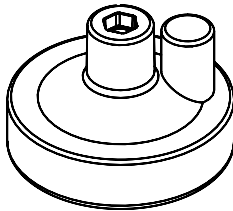

The wrench is used to tighten the Gutta Percha Injecting Needle and its connection to Hot Melting and Filling Instrument. After tighten the Gutta Percha Injecting Needle, the needle can be bent to any suitable angle with wrench. Do not use other instruments to pre-bend the needle other than the wrench provided by manufacturers.

11) Cleaning brush:

To remove remaining material from inside the heating or loading slot, set the temperature to 150°C, express any remaining material and then turn off the Hot Melting and Filling Instrument. Insert cleaning brush through the back of the Hot Melting and Filling Instrument, and then pull it out through the nose of the Hot Melting and Filling Instrument. Do not put any cleaner or chemicals on the cleaning brush before inserting it into the chamber.

### 1.3 Device includes

1. Hot Melting and Filling Instrument
2. Charging base
3. Power adapter with cord
4. Gutta Percha Injecting Needles
5. Thermal Protector Cap
6. Gutta Percha Injecting Needle Protector
7. Cleaning brush
8. Pushing ram
9. Wrench
10. Instruction Manual
11. Qualified Certification
12. Warranty card
13. Packing list

<b>Model</b>	<b>Gauge</b>	<b>Length</b>
20G 22mm	20G	22mm
20G 24mm	20G	24mm

20G 28mm	20G	28mm
23G 24mm	23G	24mm
23G 28mm	23G	28mm
25G 24mm	25G	24mm

Table 2 Models of Gutta Percha Injecting Needles

#### 1.4 Introduction and scope of application

##### 1.4.1 Features:

- a) Symmetrical two-sided display and operation button design for left or right hand operation.
- b) Cordless design for Hot Melting and Filling Instrument effectively broadens the operation space.
- c) Sensitive temperature control, simple display, and convenient operation; Press temperature setting button to set suitable working temperature.
- d) Four preset temperatures are for option: 150°C, 180°C, 200°C, 230°C
- e) Safe protecting system. If there is no operation for 10 minutes, the Hot Melting and Filling Instrument will automatically shut down.

##### 1.4.2 Scope of application:

Only used in endodontic filling with gutta-percha or root canal sealant. Fi-G is equipped with Gutta Percha Injecting Needle and Thermal Protector Cap to heat up and soften gutta-percha to backfill root canal.

#### 1.5 Product specifications

Sizes	Hot Melting and Filling Instrument	31.9mm×152.5mm×114.9mm
	Charging base	75.5mm×149.7mm×62.6mm
Weight	Hot Melting and Filling Instrument	170g
	Charging base	207g
	Power adapter	167g

#### 1.6 Technical parameters

Classification	Class II(AC/DC power adapter)
Optional preset temperatures	150°C→180°C→200°C→230°C
Time consumption for charging	About 2.5h (First charging needs 3 h)

Power supply	Input	AC100V-240V 50/60Hz 800mA
	Output	DC15V/1.6A
Battery capacity	Chargeable battery	2000mAh
Heater Rating	10W	

### 1.7 Environmental parameters

Working condition	Temperature	+5°C ~ +40°C
	Humidity	30% ~ 75%
	Air pressure	70kPa ~ 106kPa

### 1.8 Storage and transport

1. The device should be handled carefully and lightly. Be sure that it is far from the vibration, and is installed or kept in a cool, dry, and ventilated place.

2. Do not store the device together with the articles that are combustible poisonous, caustic, or explosive.

3. The device should be stored in a room where the relative humidity is 10% ~ 93%, the air pressure is 70kPa ~ 106kPa, and the temperature is -20°C ~ +55°C.

4. Please avoid the device from strong shock or vibration during transport. And please handle it carefully.







5. Please do not mix the device with hazardous articles during transport.











6. Please avoid the device from sun, rain, and snow during transport.

## 2 European authorized representative

<b>EC REP</b>	MedNet EC-REP C IIb GmbH Borkstrasse 10 · 48163 Muenster · Germany
---------------	---

## 3 Standard icons

	Product serial number		Follow Instructions for Use
	Manufacturer		Date of manufacture
	Type B applied part		Class II device

	Power switch	<b>IPX0</b>	Ordinary equipment
	Used indoor only		Caution, hot surface
	Can be autoclaved	DC 15V	DC 15V
	Rectilinear motion	<b>CE</b> <sup>0197</sup>	CE marked product
	Device complies with WEEE directive		
	Attention! Please refer to the accompanying documents.		
	Humidity limit for storage: 10% ~ 93%		
	Atmospheric pressure for storage: 70kPa ~ 106kPa		
	Temperature limit for storage: -20°C ~ +55°C		
	Authorised Representative in the EUROPEAN COMMUNITY		

## 4 Contraindications

1. People who are allergic to known natural latex and metals such as stainless steel, silver, copper, etc. are forbidden to use this device.
2. The patient with hemophilia is forbidden to use this device.
3. The patients with heart pacemaker are forbidden to use this device.
4. The dentists with heart pacemaker are forbidden to use this device.
5. Heart disease patients, pregnant women and children should be cautious to use the equipment.

## 5 Installation and disassembly method of accessories

### 5.1 Connection of power adapter

Connect the output point of power adapter to the charging base, and connect the input point to the socket that meets the standard of this power adapter. Please install in accordance with the procedures in Figure 2, Figure 3, and Figure 4.

### 5.2 Installation, disassembly and pre-bent of Gutta Percha Injecting

## Needle

Note: In order to prevent from scalding, when replace the Gutta Percha Injecting Needle, please first power off and wait for 5 minutes. Only after the heating chamber cools down, the replacement can start.

1. Power off the device and wait for 5 minutes until the Hot Melting and Filling Instrument cools down. And then use wrench to disassemble the needle in counter-clockwise direction.
2. Place the used needle in the dedicated container.
3. Select needed Gutta Percha Injecting Needle (20ga, 23ga or 25ga. Please refer to Table 2 for details.), and tighten the needle to the Hot Melting and Filling Instrument in clockwise direction. Please be cautious not to over tighten.
4. Use wrench to bend the needle to needed angle.

## 5.3 Installation and disassembly of Thermal Protector Cap

Start installation and disassembly from head part of the Hot Melting and Filling Instrument.

## 5.4 Removal and replacement of battery

When replace the battery, first loosen the fixing screw with a screwdriver, then remove the battery cover, next remove the old battery, replace it with a new one, and finally cover the battery cover and tighten the screws.

### **Warning:**

Improper replacement of lithium batteries may result in unacceptable risks,so replacement of lithium batteries requires trained personnel.

## 5.5 Installation and disassembly of pushing ram

When pulling out the pushing ram, the limit switch must be kept pressed.

The pushing ram can only be plugged in or unplugged from tail part of the Hot Melting and Filling Instrument.

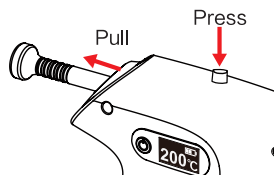

## 6 Operation method

**Note:** During use, please do not contact the heating part of the Hot Melting and Filling Instrument. Before use, remember to install the Thermal Protector Cap to prevent users or patients from scalding.

### 1. Choose Gutta Percha Injecting Needle

Choose suitable Gutta Percha Injecting Needle (20ga, 23ga or 25ga) according to the situation of patient. And tighten the Gutta Percha Injecting Needle and handpiece (Note: not too tight). When using, the Gutta Percha Injecting Needle can rotate to suitable angle within the range of 360° in clockwise direction and counterclockwise direction. And you can also use wrench to pre-bend the needle and adjust it to a better operation angle as per your needs.

### **Warning:**

① When install the Injecting Needle, please be sure that the device is off and the head part of the device is cooling down. (About 5 minutes after shutdown of the Hot Melting and Filling Instrument, the head part of it can cool down to the temperature that allows people to touch.)

② The pre-bending angle of the Injecting Needle cannot exceed 90°, and do not bend in the size transitional parts of the needle.

### 2. Choose the gutta-percha

Choose suitable gutta-percha for the device. Before loading it into the loading slot, pull the pushing ram back (do not pull out) to empty the loading slot with pressing the limit switch all the time, and then tilt the head of the Hot Melting and Filling Instrument down. After tilting the head part for an certain angle, put the gutta-percha into the loading slot, and then use the pushing ram to push the gutta-percha into the heating chamber completely (Note: only one gutta-percha stick can be placed at a time). When the gutta-percha completely enters the heating chamber, the black marker circle of the pushing ram will fully advance into the Hot Melting and Filling Instrument. Failure to fully fit the gutta-percha into the heating chamber will result in function failure of the device.

### 3. Power on

After powering on with long press on “ON/OFF” button, the device will automatically heat up to the preset temperature. If you want to change the preset temperature, please continuously press the temperature control button until the display screen displays the needed temperature value. After each press, the temperature will change once in the sequence

of 150°C->180°C->200°C->230°C. And it will back to 150°C when you press the button while at 230°C. During operation, please refer to Table 1 Recommended temperature setting to set suitable temperature. One second after setting suitable temperature, the display screen will automatically skip to display the actual heating temperature. And it will heat up until reach the preset temperature. If the machine is left idle for more than about 2.5 minutes, the machine will automatically enter the power saving mode and the temperature will drop to 150°C to save power. When the machine is picked up, the machine will automatically return to the set temperature value. Pull the trigger to push the pushing ram forward until there is a small amount of extrusive gutta-percha in the needle.

Note: The displaying temperature is the temperature inside the heating chamber.

#### 4. Canal obturation

Install the Thermal Protector Cap at the connecting part of Gutta Percha Injecting Needle and Hot Melting and Filling Instrument, and wipe the filling material from the needle with gauze and alcohol. Note: The needle is hot at this time, and the needle starts filling from the bottom of the root canal to reduce or avoid the generation of bubbles. Place the needle at the bottom of the root canal. Pull the trigger to squeeze the gutta-percha, and slowly retract the needle until reach the crown hole.

#### **Warning:**

When the trigger is squeezed to fill the gutta-percha without retracting the needle, the needle may break. While the gutta-percha is still hot, use a medical vertical presser to squeeze down. If there are bubbles in the root canal, use a small amount of material to fill the root canal for many times. Use a little more material for each filling and use vertical presser to press it down.

#### 5. Replacement of gutta-percha

When the trigger is pushed forward to push the push ram to make a "click" sound, it indicates that the gutta-percha in the Hot Melting and Filling Instrument has been used up. And it is necessary to load a new gutta-percha stick in time. When loading another gutta-percha stick, make sure the Hot Melting and Filling Instrument has cooled to room temperature. When the previous gutta-percha has been completely squeezed out, then according to step 2, re-select the appropriate gutta-percha for loading.

 **Warning:**

Do not replace the gutta-percha stick in the heated state, otherwise it may cause scalding or damage the Hot Melting and Filling Instrument.

6. After operation, the remaining materials in the heating chamber must be cleaned, and the relevant accessories must be cleaned, disinfected and sterilized. For details, see Chapter 9.

## **7 Charging instruction**

7.1 Use corresponding charging base for charging: Connect the power adapter to the charging base, and connect to power supply. And then correctly place the Hot Melting and Filling Instrument in the charging base. When the Hot Melting and Filling Instrument is not placed on the charging base, the indicator will flashes in yellow and green alternately. When the Hot Melting and Filling Instrument is placed on the charging base, if the charging is being charged, the yellow indicator will be on constantly. When the battery is full, the yellow indicator will be off and the green indicator will be on constantly. Under normal situation, the charging takes about 2.5h.

7.2 The battery used in this product has no memory and can be used at any time or charged at any time.

7.3 Before first use of this device, please charge it at least for 3 hours.

 **Warning:**

Only unplug the adapter to disconnect from the network power.

## **8 Safety precautions**

1. Do not use instruments other than the provided wrench to install, disassemble or pre-bent Gutta Percha Injecting Needle.

2. Do not knock or scratch the Hot Melting and Filling Instrument.

3. Keep heat carrier accessories such as Hot Melting and Filling Instrument, Gutta Percha Injecting Needle, Thermal Protector Cap etc. under heating state away from inflammable and explosive materials.

4. Please keep the device clean before and after operation. Before each use, please clean, disinfect and sterilize the accessories such as Gutta Percha Injecting Needle, Thermal Protector Cap and wrench.

5. The product should be in strict accordance with relevant operation specifications of medical authority and relative regulations. The product can only be operated by trained doctors or technicians.



6. Do not install, remove, or replace the Thermal Protector Cap and needle under heating state. If you need to replace the needle, please first power off and wait for 5 minutes. Five minutes later, if the Hot Melting and Filling Instrument totally cools down, replace the needle.

7. The needle must be correctly installed to prevent from falling off or gutta-percha leakage during operation.

8. Do not use excessive force when pre-bending the injection needle to prevent the needle from breaking. When the needle is bent or worn, the gutta-percha flowing ability may be deteriorated, and the operator should replace the new needle in time according to the clinical condition;

9. Woodpecker is specialized in producing medical instrument.

We are only responsible for the safety on the following conditions:

a) The maintenance, repair, and modification are made by the manufacturer or the authorized dealers.

b) The charged components are original of “Woodpecker” and operated according to instruction manual.

## **9 Cleaning, Disinfection, Sterilization and Maintenance**

The cleaning, disinfection and sterilization of Gutta Percha Injecting Needle. Unless otherwise stated, it will be hereinafter referred to as “product”.

### **Warnings**

The use of strong detergent and disinfectant (alkaline pH>9 or acid pH <5) will reduce the life span of product. And in such cases, the manufacturer takes no responsibility. This product shall not be exposed to high temperature above 138°C.

#### 9.1 Processing limit

This product is a one-time use product. But follow the steps to clean, disinfect and sterilize before use.

#### 9.2 Initial processing

##### 9.2.1 Processing principles

It is only possible to carry out effective sterilization after the completion of effective cleaning and disinfection. Please ensure that, as part of your responsibility for the sterility of product before use, only sufficiently validated equipment and product-specific procedures are used for cleaning/disinfection and sterilization, Please also observe the

applicable legal requirements in your country as well as the hygiene regulations of the hospital or clinic, especially with regard to the additional requirements for the inactivation of prions.

#### 9.2.2 Post-operative treatment

The post-operative treatment must be carried out immediately, no later than 30 minutes after the completion of the operation. The steps are as follows:

1. Remove the injection needle please refer to section 5.2.
2. Remove the remaining Gutta Percha materials in the Backfilling Handpiece. For specific operations, please refer to point 11 in section 1.2



#### **Warnings**

The injection needle after surgery cannot be used again.

#### 9.2.3 Preparation before cleaning

##### Steps

Tools: Wrench ,tray, clean and dry soft cloth.

1. Installing the injection needle Refer to section 5.2.
2. Squeeze out the Gutta Percha materials in the Backfilling Handpiece and ensure that the Gutta Percha materials injected from the Gutta Percha Injecting Needle exceed 30mm.
3. Remove the Gutta Percha Injecting Needle from the handle with the wrench provided by guilin woodpecker medical instrument co., LTD. Then Put them into a clean tray.
4. Clean the surface of Gutta Percha Injecting Needle until no dirt can be seen on the surface. Then dry it with a soft cloth and put them into a clean tray. Cleaning agent can be pure water.

##### Notes:

The pure water temperature should not exceed 45 °C, otherwise the protein will solidify and it is difficult to remove.

#### 9.3 Cleaning

The cleaning should be performed no later than 24 hours after the operation. The cleaning adopt automated cleaning.

The cleaning procedure are as follows.

- 1) Pre-wash with pure water at 25 ° C for 3 minutes.
- 2) Clean with the condition recommended by the cleaning agent manufacturer for 5 minutes. For example the detergent use RUHOF ENDOZIME AW PLUS WITH APA, Dilution Ratio 1: 270, temperature 25°C. Clean for 5 minutes.
- 3) Rinse twice with pure water at 25 ° C for 1 minute each.

Notes:

a) The solution used the pure water and only freshly prepared solutions can be used.

b) During the use of cleaner, the concentration and time provided by manufacturer shall be obeyed.

c) The cleaner is proved to be valid by CE certification in accordance with EN ISO 15883.

d) The cleaning procedure is suitable for the product, and the irrigating period is sufficient.

#### 9.4 Disinfection

Disinfection must be performed no later than 2 hours after the cleaning phase. Automated disinfection is preferred if conditions permit.

For the thermal disinfection here, the temperature is 93 ° C, the time is 5 min, and A0 > 3000.

Cleaning and disinfecting steps by using Washer-disinfector

1. Carefully place the product into the disinfection basket. Fixation of product is needed only when the product is removable in the device. The product is not allowed to contact each other.

2. Start the program.

3. After the program is finished, remove the product from the washer-disinfector, inspect (refer to section "Inspection and Maintenance") and packaging (refer to chapter "Packaging"). Dry the product repeatedly if necessary (refer to section "Drying").

The intrinsic suitability of the product for effective cleaning and disinfection using the above automated cleaning and disinfection procedures was verified by a certified facility.

Notes:

a) Before use the washer-disinfector, you must carefully read the operating instructions provided by the equipment manufacturer to familiarize yourself with the disinfection process and precautions.

b) With this equipment, cleaning, disinfection and drying will be carried out together.

c) Only distilled or deionized water with a small amount of microorganisms (<10 cfu/ml) can be used for all rinsing steps. (For example, pure water that is in accordance with the European Pharmacopoeia or the United States Pharmacopoeia).

d) The air used for drying must be filtered by HEPA.

e) Regularly repair and inspect the disinfector.

## 9.5 Drying

If your cleaning and disinfection process does not have an automatic drying function, dry it after cleaning and disinfection.

### Methods

1. Spread a clean white paper (white cloth) on the flat table, point the product against the white paper (white cloth), and then dry the product with filtered dry compressed air (maximum pressure 3 bar). Until no liquid is sprayed onto the white paper (white cloth), the product drying is completed.

2. It can also be dried directly in a medical drying cabinet (or oven). The recommended drying temperature is 80°C~120°C and the time should be 15~40 minutes.

### Notes:

- a) The drying of product must be performed in a clean place.
- b) The drying temperature should not exceed 138 °C;
- c) The equipment used should be inspected and maintained regularly.

## 9.6 Inspection and maintenance

In this chapter, we only check the appearance of the product. After inspection, ensure that there is no problem.

9.6.1 Check the product. If there is still visible stain on the product after cleaning/ disinfection, the entire cleaning/disinfection process must be repeated.

9.6.2 Check the product. If it is obviously damaged, smashed, detached, corroded, it must be scrapped and not allowed to continue to be used.

9.6.3 Check the product. If the accessory is found to be damaged, please replace it before use. And the new accessory for replacement must be cleaned, disinfected and dried.

9.6.4 If the number of times of the product reaches the specified number of times, please replace it in time.

## 9.7 Packaging

Install the disinfected and dried product and quickly package it in a medical sterilization bag (or special holder, sterile box).

### Notes:

- a) The package used conforms to ISO 11607;
- b) It can withstand high temperature of 138 °C and has sufficient steam permeability;

c) The packaging environment and related tools must be cleaned regularly to ensure cleanliness and prevent the introduction of contaminants;

d) Avoid contact with parts of different metals when packaging.

### 9.8 Sterilization

Use only the following steam sterilization procedures (fractional pre-vacuum procedure\*) for sterilization, and other sterilization procedures are not recommended:

1. The steam sterilizer complies with EN13060 or is certified according to EN 285 to comply with EN ISO 17665;

2. The sterilization time is 5 minutes at a temperature of 134°C and a pressure of 2.0 bar ~ 2.3 bars.

Verification of the fundamental suitability of the products for effective steam sterilization was provided by a verified testing laboratory.

Notes:

a) Only the product that have been effectively cleaned and disinfected are allowed to be sterilized;

b) Before using the sterilizer for sterilization, read the Instruction Manual provided by the equipment manufacturer and follow the instructions.

c) Do not use hot air sterilization and radiation sterilization as this may result in damage to the product;

d) Please use the recommended sterilization procedures for sterilization. It is not recommended to sterilize with other sterilization procedures such as ethylene oxide, formaldehyde and low temperature plasma sterilization. The manufacturer assumes no responsibility for the procedures that have not been recommended. If you use the sterilization procedures that have not been recommended, please adhere to related effective standards and verify the suitability and effectiveness.

\* Fractional pre-vacuum procedure = steam sterilization with repetitive pre--vacuum. The procedure used here is to perform steam sterilization through three pre-vacuums.

### 9.9 Storage

9.9.1 Store in a clean, dry, ventilated, non-corrosive atmosphere with a relative humidity of 10% to 93%, an atmospheric pressure of 70KPa to 106KPa, and a temperature of -20 °C to +55 °C;

9.9.2 After sterilization, the product should be packaged in a medical sterilization bag or a clean sealing container, and stored in a special

storage cabinet. The storage time should not exceed 7 days. If it is exceeded, it should be reprocessed before use.

Notes:

a) The storage environment should be clean and must be disinfected regularly;

b) Product storage must be batched and marked and recorded.

#### 9.10 Transportation

1. Prevent excessive shock and vibration during transportation, and handle with care;

2. It should not be mixed with dangerous goods during transportation.

3. Avoid exposure to sun or rain or snow during transportation.

#### 9.11 The cleaning and disinfection of Backfilling Handpiece and charging base are as follows.

 Warnings: Do not clean the Backfilling Handpiece and charging base with ultrasound cleaning machine.

- Before each use, wipe the surface of the Backfilling Handpiece , charging base and Pushing Ram with a soft cloth or paper towel soaked in 75% medical alcohol. Repeat the wipe for at least 3 times.

- Before each use, please clean the residual Gutta Percha materials in the heating cavity.

- After each use, will host the heating chamber of residual Gutta Percha material extrusion.Unloaded the Gutta Percha Injecting Needle , then use the Cleaning Brush provided from the back of the host in them, and come out from the front of the host, clean at least 3 times, until the host fever intracavitary residual Gutta Percha material is clean.

- After each use, wipe the surface of the main engine and charging base with a clean soft cloth soaked in purified water or a clean disposable wet paper towel, and repeat for at least 3 times.

#### 9.12 Daily maintenance

When the device is not used, please turn off the power and unplug the power supply plug.

If the Hot Melting and Filling Instrument is in a low battery state for a long time, the service life of battery will be shortened. Please charge it in time if the battery level is low. When the device is not used, please charge it for 1 hour once a month.

 **Warning:**

Equipment and all accessories shall not be maintained during use  
9.13 Repair of device

This product does not contain self-repairing spare parts. If there is any abnormality in the equipment, please contact our company for maintenance and do not disassemble without authorization. With our company's consent, we will provide circuit diagrams, component part lists, descriptions, calibration instructions to assist to SERVICE PERSONNEL in parts repair.

## 10 Troubleshooting

Fault	Cause	Solution
After pressing the “ON/OFF” button, the device is still off.	<ol style="list-style-type: none"> <li>1. Inadequate battery power</li> <li>2. Battery is damaged.</li> <li>3. The charging interface is short-circuited, causing the lithium battery to enter a protection state;</li> <li>4. Hot Melting and Filling Instrument is damaged.</li> </ol>	<ol style="list-style-type: none"> <li>1. Connect to power supply to charge. / Replace the battery.</li> <li>2. Replace the battery.</li> <li>3. Remove the substance that causes the short circuit, put the device into the charging base to charge, and then the device will return to normal;</li> <li>4. Contact local distributor or manufacturer.</li> </ol>
Gutta-percha cannot flow out from the needle	<ol style="list-style-type: none"> <li>1. The push ram has been pushed to the end, indicating that the gutta-percha has run out.</li> <li>2. The pushing ram seal ring is damaged.</li> <li>3. The needle is damaged and blocked</li> </ol>	<ol style="list-style-type: none"> <li>1. Pull back the pushing ram and load a new gutta-percha stick</li> <li>2. Replace the pushing ram</li> <li>3. Replace the needle</li> </ol>
Automatic shutdown	If there is no operation for 10 minutes, the device will automatic powers off	Reboot

The pushing ram cannot be pulled out	The portion of the pushing ram that enters the interior of the heating chamber is fixed by the cooling of the gutta-percha.	1. Power on and set the temperature to 200 °C. After the temperature reaches the set value, pull out the pushing ram back; 2. Contact your local dealer or our company.
Charging failure after connecting to power supply.	1. The power supply is not correctly connected; 2. The power supply is damaged, or the specification doesn't match. 3. There are impurities on the contact thimble of charging base.	1. Unplug and reconnect. 2. Replace the battery. 3. Wipe the thimble with alcohol, dry it, and reconnect.
The service time after each charging is shortened.	The battery capacity becomes smaller.	Send to the repair center.
ERROR code appears on display screen.	The heating chamber is damaged.	1. Send to the repair center. 2. Contact local distributor or manufacturer.

If the problem still cannot be solved, please contact your local dealer or our company.

1. When the pushing ram is in the Hot Melting and Filling Instrument, please do not push or pull the pushing ram vigorously. When the gutta-percha is heated up to the preset temperature, the pushing ram should be pushed by pulling the trigger for multiple times. If the pushing ram does not move, try to push it manually with a slight force, and try to pull the trigger.

2. Please refer to the recommended temperature to set the preset temperature.

3. To remove all remaining material, please first remove the needle, and then pull the trigger to squeeze out all the residual material in the heating chambers. Be careful not to touch the head of the Hot Melting and Filling Instrument to avoid scalding. Power off, cool it down slightly, and push the pushing ram down.



## 11 After-sales service

Since the date of sales, if the device cannot work normally for quality problem, our company will be responsible for the repair of device during the warranty period. Please refer to the Warranty Card for warranty period and warranty scope.

## 12 Environment protection

The device does not contain any harmful ingredients. It can be handled or destroyed in accordance with the relevant local regulations.

Note:

1) Without Woodpecker agreement and authorization, private modification of device may result in the electromagnetic compatibility problem of that device or other devices.

2) The design and test of Hot Melting and Filling Instrument complies with the related operation regulations of electromagnetic compatibility.

## 13 EMC-Declaration of conformity

The device has been tested and homologated in accordance with EN 60601-1-2 for EMC. This does not guarantee in any way that this device will not be effected by electromagnetic interference Avoid using the device in high electromagnetic environment.

### Technical Description Concerning Electromagnetic Emission

**Table 1: Declaration - electromagnetic emissions**

<b>Guidance and manufacturer's declaration - electromagnetic emissions</b>		
The model Fi-G is intended for use in the electromagnetic environment specified below. The customer or the user of the model Fi-G should assure that it is used in such an environment.		
Emissions test	Compliance	Electromagnetic environment - guidance
RF emissions CISPR 11	Group 1	The model Fi-G uses RF energy only for its internal function. Therefore, its RF emissions are very low and are not likely to cause any interference in nearby electronic equipment.

RF emissions CISPR11	Class B	The model Fi-G is suitable for used in all establishments, including domestic establishments and those directly connected to the public low-voltage power supply network that supplies buildings used for domestic purposes.
Harmonic emissions IEC 61000-3-2	Class A	
Voltage fluctuations / flicker emissions IEC 61000-3-3	Complies	

### Technical Description Concerning Electromagnetic Immunity

**Table 2: Guidance & Declaration - electromagnetic immunity**

<b>Guidance &amp; Declaration — electromagnetic immunity</b>			
The model Fi-G is intended for use in the electromagnetic environment specified below. The customer or the user of the model Fi-G should assure that It is used in such an environment.			
Immunity test	IEC 60601 test level	Compliance level	Electromagnetic environment - guidance
Electrostatic discharge (ESD) IEC 61000-4-2	±8kV contact ±2, ±4, ±8, ±15kV air	±8kV contact ±2, ±4, ±8, ±15kV air	Floors should be wood, concrete or ceramic tile. If floors are covered with synthetic material, the relative humidity should be at least 30 %.
Electrical fast transient/burst IEC 61000-4-4	±2kV for power supply lines ±1kV for Input/output lines	±2kV for power supply lines	Mains power quality should be that of a typical commercial or hospital environment.
Surge IEC 61000-4-5	±0.5, ±1kV line to line ±0.5, ±1, ±2kV line to earth	±0.5, ±1kV line to line ±0.5, ±1, ±2kV line to earth	Mains power quality should be that of a typical commercial or hospital environment.

Voltage dips, short interruptions and voltage variations on power supply input lines IEC 61000-4-11	<5 % UT (>95% dip in UT.) for 0.5 cycle <5 % UT (>95% dip in UT.) for 1 cycle 70% UT (30% dip in UT) for 25 cycles <5% UT (>95 % dip in UT) for 250 cycles	<5 % UT (>95% dip in UT.) for 0.5 cycle <5 % UT (>95% dip in UT.) for 1 cycle 70% UT (30% dip in UT) for 25 cycles <5% UT (>95 % dip in UT) for 250 cycles	Mains power quality should be that of a typical commercial or hospital environment. If the user of the models Fi-G requires continued operation during power mains interruptions, it is recommended that the models Fi-G be powered from an uninterruptible power supply or a battery.
Power frequency (50/60 Hz) magnetic field IEC 61000-4-8	30A/m	30A/m	Power frequency magnetic fields should be at levels characteristic of a typical location in a typical commercial or hospital environment.
NOTE UT is the a.c. mains voltage prior to application of the test level.			

**Table 3: Guidance & Declaration - electromagnetic immunity concerning Conducted RF & Radiated RF**

<b>Guidance &amp; Declaration - Electromagnetic immunity</b>			
The model Fi-G is intended for use in the electromagnetic environment specified below. The customer or the user of the models Fi-G should assure that it is used in such an environment.			
Immunity test	IEC 60601 test level	Compliance level	Electromagnetic environment - guidance

Conducted RF IEC 61000-4-6	3 Vrms 150 kHz to 80 MHz	3V 6V 3V/m	Portable and mobile RF communications equipment should be used no closer to any part of the models Fi-G, including cables, than the recommended separation distance calculated from the equation applicable to the frequency of the transmitter. Recommended separation distance $d=1.2 \times P^{1/2}$ $d=2 \times P^{1/2}$ $d=1.2 \times P^{1/2}$ 80 MHz to 800 MHz $d=2.3 \times P^{1/2}$ 800 MHz to 2.7 GHz where P is the maximum output power rating of the transmitter in watts (W) according to the transmitter manufacturer and d is the recommended separation distance in meters (m). Field strengths from fixed RF transmitters, as determined by an electromagnetic site survey, <sup>a</sup> should be less than the compliance level in each frequency range. <sup>b</sup> Interference may occur in the vicinity of equipment marked with the following symbol:
Conducted RF IEC 61000-4-6	6 Vrms		
Radiated RF IEC 61000-4-3	ISM frequency band 3 V/m 80 MHz to 2.7 GHz		
NOTE 1 At 80 MHz end 800 MHz. the higher frequency range applies. NOTE 2 These guidelines may not apply in all situations. Electromagnetic propagation is affected by absorption and reflection from structures, objects and people.			
<p><sup>a</sup> Field strengths from fixed transmitters, such as base stations for radio (cellular/cordless) telephones and land mobile radios, amateur radio, AM and FM radio broadcast and TV broadcast cannot be predicted theoretically with accuracy. To assess the electromagnetic environment due to fixed RF transmitters, an electromagnetic site survey should be considered. If the measured field strength in the location in which the model Fi-G is used exceeds the applicable RF compliance level above, the model Fi-G should be observed to verify normal operation. If abnormal performance is observed, additional measures may be necessary, such as reorienting or relocating the model Fi-G.</p> <p><sup>b</sup> Over the frequency range 150 kHz to 80 MHz, field strengths should be less than 3V/m.</p>			

**Table 4: Recommended separation distances between portable and mobile RF communications equipment and the model Fi-G**

<b>Recommended separation distances between portable and mobile RF communications equipment and the model Fi-G</b>			
The model Fi-G is intended for use in electromagnetic environment in which radiated RF disturbances is controlled. The customer or the user of the model Fi-G can help prevent electromagnetic interference by maintaining a minimum distance between portable and mobile RF communications equipment (transmitters) and the model Fi-G as recommended below, according to the maximum output power of the communications equipment.			
Rated maximum output power of transmitter W	Separation distance according to frequency of transmitter m		
	150kHz to 80MHz $d=1.2 \times P^{1/2}$	80MHz to 800MHz $d=1.2 \times P^{1/2}$	800MHz to 2,7GHz $d=2.3 \times P^{1/2}$
0,01	0.12	0.12	0.23
0,1	0.38	0.38	0.73
1	1.2	1.2	2.3
10	3.8	3.8	7.3
100	12	12	23
For transmitters rated at a maximum output power not listed above, the recommended separation distance d in meters (m) can be estimated using the equation applicable to the frequency of the transmitter, where P is the maximum output power rating of the transmitter in watts (W) accordable to the transmitter manufacturer. NOTE 1 At 80 MHz and 800 MHz. the separation distance for the higher frequency range applies. NOTE 2 These guidelines may not apply in all situations. Electromagnetic propagation is affected by absorption and reflection from structures, objects and people.			

## **14 Statement**

Woodpecker reserves the right to change the design of the equipment, the technique, fittings, instruction manual and the content of the original packing list at any time without further notice. The pictures are only for reference. The final interpretation rights belong to Guilin Woodpecker Medical Instrument Co., Ltd.

Scan and Login website  
for more information



**Guilin Woodpecker Medical Instrument Co.,Ltd.**

Information Industrial Park, Guilin National High-Tech

Zone, Guilin, Guangxi, 541004 P. R. China

Sales Dept.: +86-773-5873196/2350599

After-sales Service Dept.: 0773-5827898

E-mail: woodpecker4@glwoodpecker.com

Website: <http://www.glwoodpecker.com>



MedNet EC-REP C IIb GmbH  
Borkstrasse 10 · 48163 Muenster · Germany

Cut along the dashed line

**Gutta percha Obturation Device  
Warranty Card**

Name of Customer		( I ) For Distributor
Address Details		
Postal Code		
Tel		
Model		
Product No.		
Purchase Date		
Contact Person		
Date	Maintenance Record	Repairer

 **Guilin Woodpecker Medical Instrument Co.,Ltd.**  
 Information Industrial Park, Guilin National High-Tech Zone, Guilin, Guangxi, 541004 P. R. China  
 Sales Dept.: +86-773-5873196/2350599  
 After-sales Service Dept.: +86-0773-5827898  
 E-mail: woodpecker4@glwoodpecker.com  
 Website: http://www.glwoodpecker.com

Distributor:	Seal
--------------	------

**Gutta percha Obturation Device  
Warranty Card**

Name of Customer		( II ) Return to Manufacturer
Address Details		
Postal Code		
Tel		
Model		
Product No.		
Purchase Date		
Contact Person		
Date	Maintenance Record	Repairer

 **Guilin Woodpecker Medical Instrument Co.,Ltd.**  
 Information Industrial Park, Guilin National High-Tech Zone, Guilin, Guangxi, 541004 P. R. China  
 Sales Dept.: +86-773-5873196/2350599  
 After-sales Service Dept.: +86-0773-5827898  
 E-mail: woodpecker4@glwoodpecker.com  
 Website: http://www.glwoodpecker.com

Distributor:	Seal
--------------	------

## Warranty Instruction

### I Period validity:

Since the date of sales, our company will be responsible for the repair of main unit, charging stand, and power adapter for one year. Please refer to the Warranty Card for warranty period and warranty scope. The warranty period of lithium battery is one year.

### II Range of warranty:

Within the warranty period of validity, we are responsible for any troubles caused by quality problems or products technique and structure.

### III The following are beyond our warranty:

1. The damage caused by disobeying the operation instruction or lack of the needed condition.
2. The damage caused by unsuitable operation or disassembly without authorization.
3. The damage caused by unadvisable transportation or preservation.
4. There isn't the seal of distributor or the warranty card isn't filled in completed.
5. Except for the main unit, charging stand, power adapter and lithium battery, the other accessories are not covered by the warranty.

## Warranty Instruction

### I Period validity:

Since the date of sales, our company will be responsible for the repair of main unit, charging stand, and power adapter for one year. Please refer to the Warranty Card for warranty period and warranty scope. The warranty period of lithium battery is one year.

### II Range of warranty:

Within the warranty period of validity, we are responsible for any troubles caused by quality problems or products technique and structure.

### III The following are beyond our warranty:

1. The damage caused by disobeying the operation instruction or lack of the needed condition.
2. The damage caused by unsuitable operation or disassembly without authorization.
3. The damage caused by unadvisable transportation or preservation.
4. There isn't the seal of distributor or the warranty card isn't filled in completed.
5. Except for the main unit, charging stand, power adapter and lithium battery, the other accessories are not covered by the warranty.